



User Guide

INDUSTREX M37 Plus Film Processor

Non-Destructive Testing (NDT) Applications



Software: AT600 v3.6d and up

Table of Contents

Introduction	3
User Guide Conventions	3
Special Messages	3
Product Description	4
Hazard Sticker	4
Technical Specifications	4
Qualified Staff	4
General Considerations	4
Mechanical Hazards	4
WEEE and RoHS Compliance Statement	7
Tanks and Chemicals	8
Draining the Tanks	8
Installing the Transport Racks	9
Filling the Tanks	12
Fill the Fixer Tank	12
Fill the Developer Tank	13
Operating the Film Processor	15
Daily Startup	15
Start Working	15
Daily Shutdown	15
Functions	16
Using the Display	17
Overview	17
Programming the Values	18
Changing the Program	18
Setting the Date and Time	19
Check the Parameters and the Work in Progress in Automatic Mode	19
Use the Options in Standby Mode	20
Use the Manual Replenishment Cycle	21
Check the Errors	21
Start and Stop the Film Processor Manually	21
Turn the Back Light On and Off	21
Check the Processing Parameters	21
Loading the Film	22
Using the Monitor Mode	22
Using the Filter Control	23
Additional Features – Auto-fill Water / Auto-fill Chemicals (Dev & Fix)	23
Automatic Wash Tank Fill	23
Automatic Developer and Fixer Tank Fill	23
Systems	25
Tempering	25
Temperature Sensing	25
I2C Bus	26
Ventilation	26
Chemical Replenishment	27
Infrared Sensor Bar	28
Maintenance, Troubleshooting, and Error Messages	29
Daily Maintenance	29
Weekly Maintenance	30
Three-to-Six Months Maintenance	30
Troubleshooting	32
Error Messages	35
Publication History	36

Introduction

The information contained herein is based on the experience and knowledge relating to the subject matter gained by the manufacturer prior to publication. No patent license is granted by this information. The manufacturer reserves the right to change this information without notice and makes no warranty, express or implied, with respect to this information. The manufacturer shall not be liable for any loss or damage, including consequential or special damages, resulting from the use of this information, even if loss or damage is caused by the manufacturer's negligence or fault.



Note: This equipment has been tested and found to comply with the limits for a Class A digital device, pursuant to part 15 of the FCC rules. These limits are designed to provide reasonable protection against harmful interference when the equipment is operated in a commercial environment. This equipment generates, uses, and can radiate radio frequency energy and, if not installed and used in accordance with the instruction manual, may cause harmful interference to radio communications. Operation of this equipment in a residential area is likely to cause harmful interference, in which case the user will be required to correct the interference at his own expense.



CAUTION:

Personnel operating and maintaining the film processor should receive training and be familiar with all aspects of operation and maintenance. Observe all Warnings, Cautions, and Important notes.

When doing the procedures in this document, you must use safe work practices and wear the correct personal protective equipment (for example, safety eyewear) according to your company's standard operating procedures.

User Guide Conventions

Special Messages

The following special messages emphasize information or indicate potential risks to personnel or equipment.



CAUTION:

Caution points out a potentially hazardous situation which, if not avoided, might cause minor or moderate injury.



ESD:

Electrostatic discharge (ESD) is a primary source of product downtime, lost productivity, and costly repairs. As few as 30 VDC can damage or destroy the essential components in electronic equipment.



IMPORTANT:

Important highlights critical policy information that affects how you use this manual and this product.



NOTE:

Notes provide additional information, such as expanded explanations, hints, or reminders.



CAUTION:

If you witness or become aware of a potential safety issue with this equipment, take the appropriate safety measures and report this to your Carestream Service representative immediately.

Typeface Conventions:

Boldface type represents buttons or selections the user makes on the interface and identifies screen names, cautions, and warnings.

Product Description

This film processor has been designed to meet the highest technical standards. Its design features include:

- Compact, space-saving design
- Fully automatic processing cycle
- Smooth roller transport system
- Low tank volumes
- Electronically controlled temperature system
- Automatic replenishment based on the film area
- Low energy consumption

Hazard Sticker



The hazard sticker is applied to covers where applicable. You must isolate the electrical power supply before opening the cover.

Technical Specifications

For technical specifications, see the Technical Data / Reference doc for the film processor.

Qualified Staff



CAUTION:

- Only trained staff can unpack and/or operate the film processor. Only trained service engineers may work on the equipment and electrical installation.
- Staff in charge of maintaining the film processor must be thoroughly familiar with the equipment and trained. The film processor should not be operated without supervision.
- The operator may remove only the top cover of the film processor.
- The installation, service, repair, and initial operation of the film processor must be carried out only by qualified and trained service personnel.
- Do not operate the film processor after consuming alcohol or taking strong medication.

General Considerations



CAUTION: Electrical Hazards

- Observe all safety warnings to minimize the risk of electrical shock, burns, or equipment damage.
- High voltage is used to power the film processor.



CAUTION:

- The film processor is a complex device with moving parts such as rotating gears and roller components. It uses photo processing chemicals that are irritating to the eyes, lungs, and skin.
- Photographic film processors are complex machines with many electrical and mechanical parts and chemicals.

Mechanical Hazards



CAUTION:

- Observe all safety warnings to minimize the risks of mechanical hazards.
- Do not wear jewelry or loose clothing when operating the processor. Check that clothing or other objects cannot get trapped in the gear drives or the roller transport system within the film processor.
- The roller transport system of the film processor is a potential hazard. Fingers, loose clothing, or jewelry can get drawn into the rollers or gear wheels.



CAUTION: Crushing of Hands

Hands or fingers may be pinched or injured by the moving parts or when handling the heavy parts.

**CAUTION: Heavy Parts**

Parts are heavy. Use caution and safe handling techniques when moving heavy parts.

**CAUTION: Electrical Hazards**

- During installation, service personnel must certify that the film processor is permanently and reliably grounded according to the standards in the national electrical code.
- Before doing any maintenance, the film processor must be isolated from the mains power by moving the mains power switch to the off (0) position.
- Built-in safety devices must not be bypassed or made inoperative. Only use the original COLENTA spare parts when replacing any failed electrical components.
- Hazardous voltage can cause electrical shocks, burns, or fatal injury.

**CAUTION: Fire Hazards**

- Beware that combustible materials can ignite and cause fires.
- Always keep an area of 3 meters surrounding the processor clean. Keep dust, wood shavings, scrap paper, or other flammable materials out of the dryer compartment.
- A functional 5 kg ABC fire extinguisher must be available in the room in which the processor is installed.
- The dryer compartment produces heat. Paper or other flammable materials can ignite.

**CAUTION: Hot Surface**

The dryer compartment produces heat. The dryer parts and covers get hot. Do not touch the dryer parts or covers when the processor is in operation. Be careful of hot surfaces.

**CAUTION: Chemical Hazards*****Corrosive Liquids*****CAUTION:**

- Chemicals may irritate the eyes, lungs, skin, and digestive tract.
- Eyes, skin, and lungs may be irritated by photo chemicals. Before using photo processing chemicals, always read the Material Safety Data Sheets (MSDS) for information about the hazards of the specific chemicals, the procedure to use them safely, and the contact information for the chemical manufacturer or dealer.
- When handling chemicals, wear safety goggles, protective gloves, and chemical aprons as indicated on the MSDS.
- To avoid hazardous situations, always keep the floors and floor coverings around the processor and associated drains clean and dry. Immediately clean and remove any accumulation of fluids outside the film processor.
- Check for proper ventilation in the areas where chemicals are prepared, used, or stored.
- Drain the tanks carefully and avoid splashing. Always drain the system thoroughly before working on any of the external hose systems. Do not allow untrained personnel to handle the photo processing chemicals or to operate the film processor.

Chemical Disposal



CAUTION:

- Waste from photographic processing normally contains diluted chemicals. These chemicals should be collected and disposed of in accordance with local environmental codes. Dumping chemicals into a drain system could lead to a pollution problem. Contact your local water treatment and sewer district authorities before disposing of chemicals.
- All plumbing must comply with local and national codes. The drain must be made of chemical-resistant and non-corroding material. Use PVC or an equivalent material.

Exhaust, Temperature, and Humidity



CAUTION:

- Proper ventilation is necessary to receive the correct processing results. Check that the exhaust hose of the built-in exhaust fan is properly connected to the exhaust air socket.
- The built-in exhaust fan removes the fumes from the film processor. These chemical fumes are corrosive.
- The top cover and the feed cover lid of the film processor should be left slightly open overnight.
- Take care when draining the processor tanks for cleaning with running water. All racks must be removed from the film processor for cleaning.



IMPORTANT:

Room temperatures between 15–30 °C (59–86 °F) with a relative humidity from 40–76 % are ideal for photographic processing and working.

Handling Chemicals and Preventing Accidents



CAUTION:

- Misuse of almost any chemical can create a hazard. Although photo chemicals are not more dangerous than most of the regular cleaning agents, there is always a risk.
- When handling chemicals, observe the following:
 - Never smell into a container or an open bottle to determine its contents. A cautious sniff of the cap or lid is safer.
 - Label the storage containers properly.
 - Avoid storing hazardous chemicals on high shelves or in unprotected glass containers.
 - Keep chemicals away from children.
 - Do not store chemicals in a refrigerator that is used for food. The chemicals can contaminate the food or be mistaken for food.
 - Observe the manufacturer's recommendations for using and mixing chemicals.
- Overexposure to photographic chemicals may cause skin irritation on some individuals.
- For photographic chemical emergencies, remember these first aid procedures:
 - Skin—Rinse thoroughly with water.
 - Eyes—Rinse thoroughly with water and consult a physician.
 - By Mouth—Consult a physician immediately.

WEEE and RoHS Compliance Statement

European Union (EU) Directives WEEE and RoHS

We are committed to being a good corporate citizen. As part of that commitment, we strive to maintain environmentally conscious manufacturing operations. The European Union (EU) has enacted two directives. The first directive, Waste Electrical and Electronic Equipment (WEEE) is for product recycling. The second directive, Restriction on the use of Hazardous Substances (RoHS) is for limiting the use of certain substances. Carestream ensures that products marketed in Europe are compliant with both regulations.



In the European Union, this symbol indicates that when the last user wishes to discard this product, it must be sent to the appropriate facility for recovery and recycling.

Contact your local representative for additional information on the collection and recovery programs available for this product.



CAUTION:

- Do not dispose the product with municipal waste.
- Special collection and disposal are required.

For the original directive text, see:

<https://eur-lex.europa.eu/legal-content/EN/TXT/?uri=CELEX%3A32006L0066&qid=1628026152001>.

You can also locate the current directives using the link above.

For more information, see the EPBA web site, <http://www.epbaeurope.net>.

Tanks and Chemicals

Draining the Tanks



CAUTION:

Wear safety goggles, gloves, and protective clothing.



ESD:

Isolate the film processor from the mains power by switching the main power switch of the film processor to the off (0) position.



1	Main power switch
2	Service cover



IMPORTANT:

Used developer and used fixer must be collected in suitable and separate containers.

1. To access the drain taps, remove the service cover.
2. Check that the containers for the developer and fixer have sufficient space available.
3. Open the drain taps for the developer, the fixer, and the wash from the film processor to remove the chemicals and water.

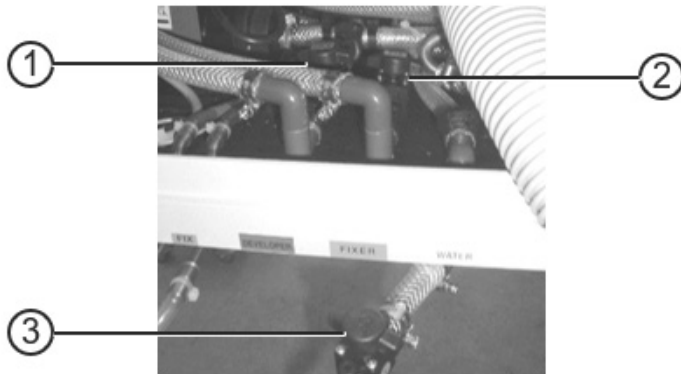

1	Developer drain tap
2	Fixer drain tap
3	Wash drain tap

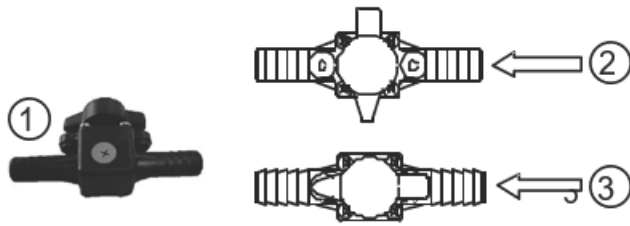

1	Drain tap
2	Closed drain tap
3	Open drain tap



IMPORTANT:

When the tanks are empty, keep the main power switch of the film processor in the off (0) position to avoid the danger of the pumps running dry and causing damage.

Before filling the tanks:

- Check that all drain taps are fully closed.
- Check the chemical tank levels before switching the main power switch of the film processor to the on (I) position.

Installing the Transport Racks



CAUTION:

- Wear safety goggles, gloves, and protective clothing.
- When handling the racks, always hold them at the upper cross beams. It is recommended that two persons handle the racks.



ESD:

Isolate the film processor from the mains power by switching the main power switch of the film processor to the off (0) position.



1	Main power switch
2	Service cover

1. Check that all the developer, fixer, and wash racks tanks are clean and free of any deposits.
2. Rinse all three tanks with warm water. Check that no algae remains in the wash tank.
3. Drain all tanks and close all taps again. See [Draining the Tanks](#).

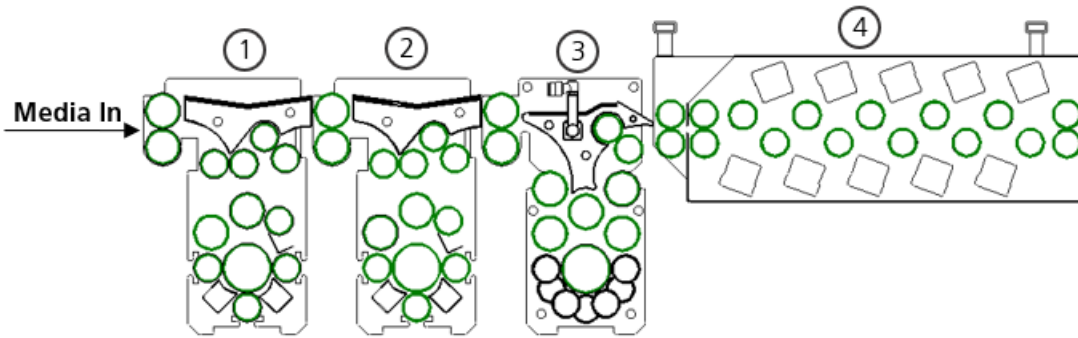
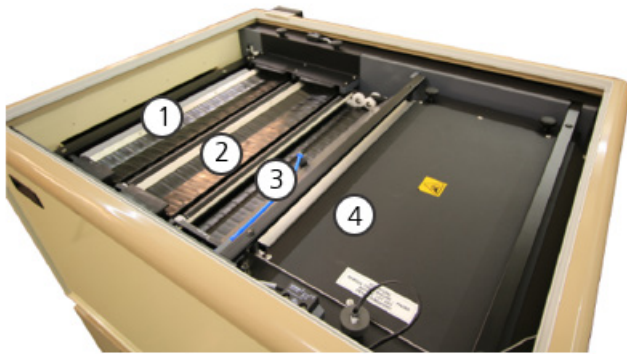

1	Developer tank
2	Fixer tank
3	Wash tank
4	Dryer

4. Fill the fixer tank to the required level and install rack 2 carefully.
5. Fill the developer tank to the required level and install rack 1 carefully.
6. Check that the wash tank is half full of water, and then place the wash rack carefully into the wash tank.
7. Check that all the racks are engaged correctly into the drive bearing.
8. Secure the racks in position using the rack locking plate.

secure the racks

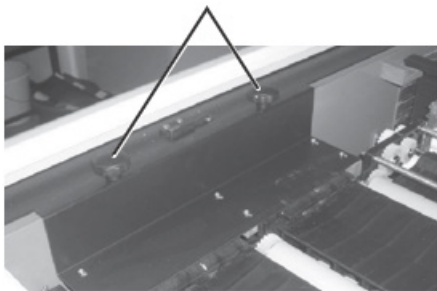

9. Place the dryer and the dryer fixing guide as shown.

secure the dryer

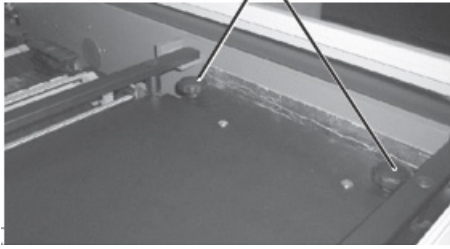

10. Insert the dryer temperature probe as shown.

Dryer temperature probe

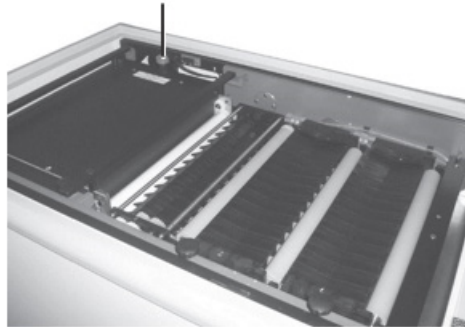

**Dryer cover
In place**

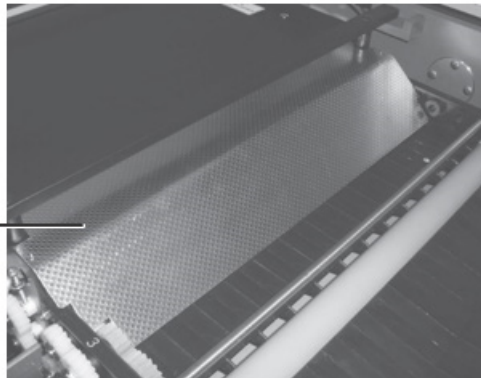

Filling the Tanks



CAUTION:

- Wear safety goggles, gloves, and protective clothing.
- Check that all related chemical safety datasheets are available.



IMPORTANT!

- Only use chemicals suitable for roller transport systems.
- Follow the instructions of the chemical manufacturers.
- Even the smallest quantity of fixer will contaminate the developer solution. Therefore, always fill the fixer first. When removing the fixer rack, always cover the developer tank. After removing the fixer rack, place onto a rack carrier/drip tray (optional accessory).



ESD:

Isolate the film processor from the mains power by switching the main power switch of the film processor to the off (0) position.



1	Main power switch
2	Service cover

Before filling the tanks:

- Check that all drain taps are fully closed.
- Check the chemical tank levels before switching the main power switch of the film processor to the on (I) position.



IMPORTANT!

The film processor features developer/fixer and fixer/wash cross-over sections that are rinsed with water. During the installation of the processor, be careful with the flow rates of water entering the developer/fixer and fixer/wash cross-over section. Depending on the local water pressure, a too-high water flow rate in the cross-over sections can result in dilution of developer and/or fixer tank solution. Use the two black taps shown below to adjust the flow rate to provide a calm and steady flow of water into each cross-over area.

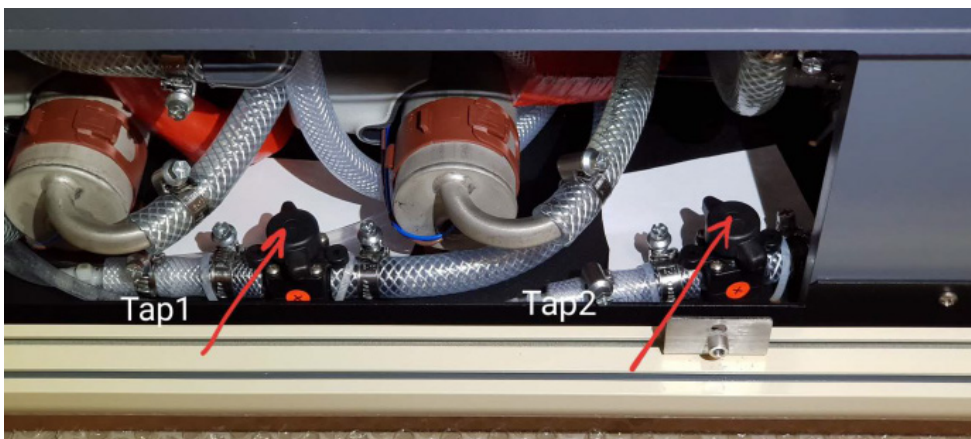

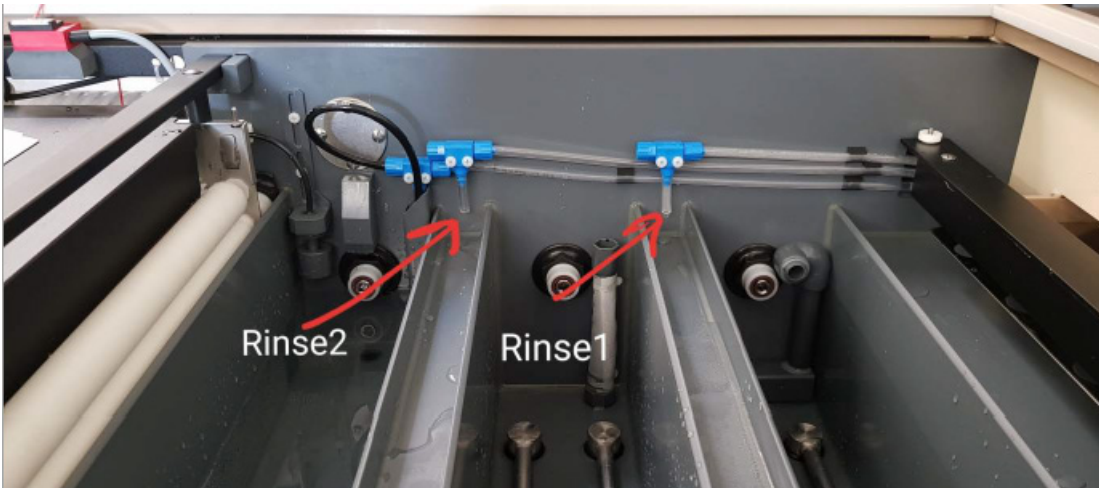

Fill the Fixer Tank

1. Empty the fixer tank by opening the fixer drain tap.
2. Remove the fixer rack.
3. Check that the fixer tank is clean and free of any deposits.
4. Close the fixer drain tap.
5. With fixer solution that is ready to use, fill the fixer tank to the red marker on the tank wall.
6. Insert the fixer rack very carefully and slowly.
7. Add a hardener solution if advised by the chemical manufacturer.

Fill the Developer Tank



IMPORTANT!

The processor features a developer filter to keep the developer clean / to reduce film artifacts. The operating position is shown below:

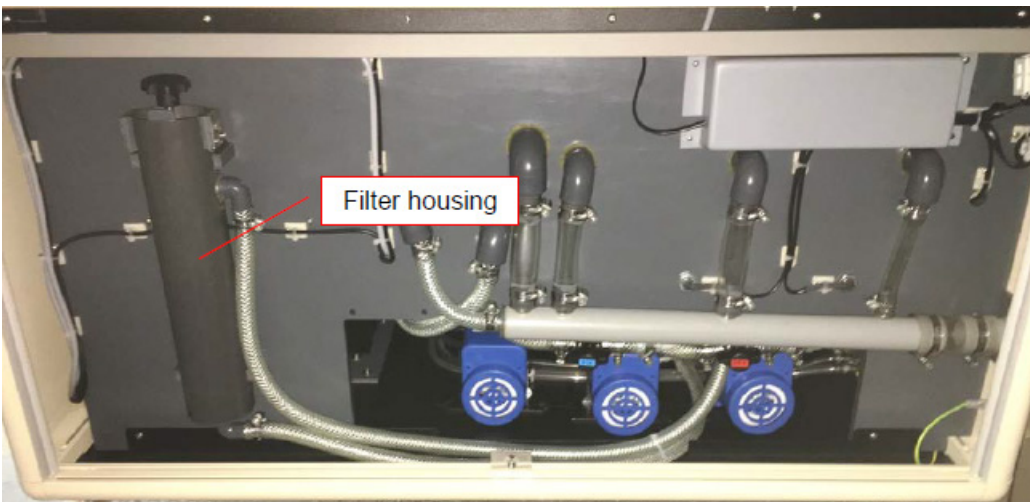

When filling the developer tank, it is important that the developer housing that holds the new filter is placed in the “down” position as shown below:



To fill the developer tank:

1. Empty the developer tank by opening the developer drain tap.
2. Remove the developer rack.
3. Check that the developer tank is clean and free of any deposits.
4. Close the developer drain tap.
5. With developer solution that is ready to use, fill the developer tank to the red marker on the tank wall.
6. Insert the developer rack very carefully and slowly.

The replenishment tanks may be used to mix the chemicals. Any remaining chemicals can be used for replenishment.

Operating the Film Processor



IMPORTANT:

In countries where the electrical supply is 60 Hz, the replenishment pumps must be adjusted to ensure that they deliver the recommended replenisher amount. Contact a qualified service provider to check and make adjustments if needed.

Daily Startup

1. Turn on the water supply.
2. Check that all tank levels are full.
3. Check that the water supply is on.
4. Press the main power switch of the processor to the on (I) position.
5. Wait for the processor to heat up. A *Ready* message appears.

Start Working

1. Check the level of the replenishment containers for the developer and fixer.
2. Check the level of the waste containers for the developer and fixer.
3. Select the required program.
4. Insert a minimum of two full-sized cleaning films.
5. When inserting the films, always check the free signal, provided on the display.
6. Check that the feed rollers accept the films and transport them smoothly.
7. Insert large format films parallel, or in-line, with the direction of the film transport.
8. Use a leader and feed table guide when processing roll film.

Daily Shutdown



CAUTION: Hot Surface

The cover of the drying rack might be hot. Do not touch.

1. Turn off the water supply.
2. Press the main power switch of the processor to the off (O) position.
3. Open the water drain tap to prevent algae growth in the water tank.



IMPORTANT:

4. Lift the top cover and the top cover lid to prevent condensation.



1	Top cover
2	Top cover lid

Functions

Function	Description
Programming	Automatic processing parameters, such as temperature, speed, and replenishment rates, can be stored in nine different programs.
Warming up	Once programmed, the temperature settings are accurately controlled. Heating starts with switching on at the mains. Constant solution temperatures are maintained in the processing tanks. Temperature tolerances of ± 0.2 °C are achieved by the microprocessor control unit. The solutions are circulated by the circulation pumps. When the temperature reaches the pre-set levels, the film processor enters Standby mode and is ready for use.
Standby	Soon after the last film exits the dryer and with the infeed sensors clear, the film processor automatically enters a Standby/Energy Saving mode. While in the Standby mode, the film processor maintains the Production Ready status.
Anti-Crystallization Cycle	During Standby mode and within a programmable cycle period, the transport and intermediate rinse bath water supply are activated to prevent a build-up of crystallization on the crossover rollers.
Anti-Oxidation Cycle	During Standby mode and when no material is processed for a set time, a pre-programmable anti-oxidation (replenishment) cycle is available to compensate for the impact of oxidation of the chemicals during Standby mode. The chemical levels in the tanks are increased, compensating for evaporation of the water in the solutions during Standby mode.
Auto Replenishment	Infrared sensors scan the film area without any direct contact to the film. After a pre-programmed amount of film or a film area has entered the processor, a replenishment cycle is activated.
Automatic Start-Stop	Infrared sensors automatically control the start cycle of the film processor. The processor changes from Standby to Run when a film interrupts the light barrier. As the rollers turn, water is supplied to the wash tank and to the intermediate rinse bath system. After the last film has passed through, the film processor reverts to Standby. The film is then removed from the receiving and collection tray.

Using the Display

Overview

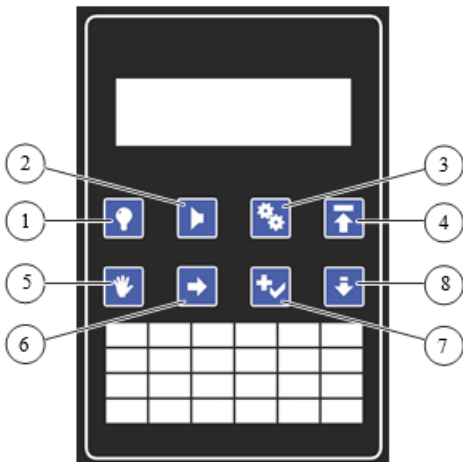

1	Back light on and off
2	Check errors and alarm shutdown
3	Setup mode
4	Return to the top menu
5	Manual operation
6	Move the cursor
7	Select the menu item and change the value
8	Scroll down the page

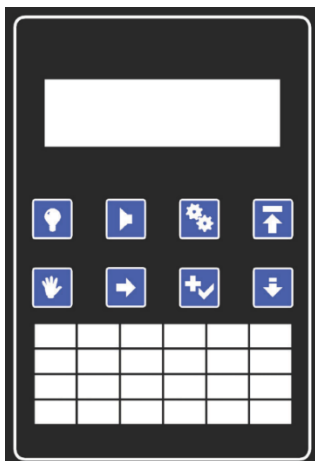

Feature	Description
Software version	AT600 v3.6d and up
Number of programs	9
Temperature range for the developer and fixer	18.0 to 43.0 °C
Temperature range for the dryer	18 to 60 °C
Temperature control tolerances	±0.2 °C
Temperature measurement resolution	0.03 °C
Developing time tolerances at maximum speed	±0.2 °C
Motor speed	Quartz-stabilized and controlled by a separate microprocessor

Programming the Values



IMPORTANT:

- Only authorized service technicians can set the values in the **Setup** menu. Although you can select the menus, scroll through the data, and make changes, the **Save** feature is disabled.
 - Use the **Program** menu only during Standby mode when the film processor is not processing media.
1. Press the main power switch of the film processor to the on (I) position. By default, the processor starts in the working mode.
 2. Press button **3**. The programming menu appears.

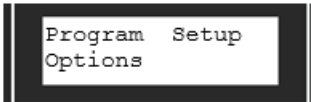

3. Press button **6** to move the cursor to **Program**, and press button **7** to select **Program**. The **Set time** menu appears. See [Setting the Date and Time](#) to set the date or time.

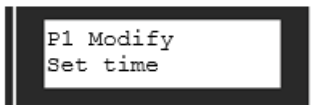

4. Press button **7** to modify the program.
5. Press button **6** to move the cursor to **Modify**, and press button **7** to select **Modify**. The program consists of four pages.
6. Press button **8** to scroll through the pages.
7. When the page you want appears:
 - a. Press button **6** to move the cursor to the value you want to set.
 - b. Press button **7** to select and change the value.
 - c. Repeat a and b for each value you want to set.
8. If you want to:

Save and store the values	Cancel the values
Press button 6 to move the cursor to Save , and press button 7 to store the values.	Press button 6 to move the cursor to Cancel , and press button 7 to cancel the values.



NOTES:

- If any of the values are set too high or too low, first an *Out of range* message appears for two seconds and then the page to change the value appears.
 - A parameter that was set too high automatically resets to the maximum possible value.
 - A parameter that was set too low automatically resets to the minimum possible value.
 - To set the highest or lowest value, you can intentionally set a value that is out of range and save it.
9. To return to the work mode, press button **4**.

Changing the Program

1. Press button **5** to change the program. The following options appear:
 - **Start**, **P1**, and **Use** are only available when the film processor is not processing media.
 - **Rep** and **Monitor** are available when processing and not processing film.
2. Press button **6** to move the cursor to **P1**, and press button **7** to select a different program.
3. Press button **6** to move the cursor to **Use**, and press button **7** to select **Use**.



NOTE:

A cyclic redundancy check is used to verify the data that is read from the non-volatile memory. If the program data is damaged, the program was set up incorrectly, or the EEPROM was replaced, then the error message *Program invalid* appears. Enter the programming mode and program the data again.

4. To return to the work mode, press button **4**.

Setting the Date and Time

1. Press button **3**.
2. Select:
 - **Program**
 - **Set time**
3. Press button **7**.
4. Set the date and time. This has no impact on the film processor's functions.
5. If you want to:

Save and store the values	Cancel the values
Press button 6 to move the cursor to Save , and press button 7 to store the values.	Press button 6 to move the cursor to Cancel , and press button 7 to cancel the values.

6. To return to the work mode, press button **4**.

Check the Parameters and the Work in Progress in Automatic Mode

The film processor is designed to operate automatically. Under normal conditions, use the display to check the processing parameters and the work in progress.

1. Press button **8** to scroll through the pages.
2. To return to the work mode, press button **4**.

If the display says:	Description
P1	Program 1 is in use.
M1	The film processor was started manually.
55% Done	55% of the developing process is complete. When it reaches 100%, the film processor changes to Standby mode.
T1=	The actual temperature in tank 1 for the developer appears. The same indication is available for tank 2 for the fixer and tank 3 for the dryer. The value is the programmed temperature.
Rep 1	The developer replenishment rate for tank 1 is indicated.
Rep 2	The fixer replenishment rate for tank 2 is indicated.
Tank1 time	The developer immersion time is indicated.
Dry to dry	The amount of time for a complete processing cycle is indicated.
Film speed	The linear speed of the media inside the film processor is indicated.
USB not conn.	For service personnel only

Use the Options in Standby Mode

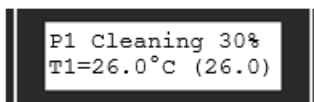

The film processor has anti-oxidation and anti-crystallization cycles. During Standby mode, the film processor rotates the transport and starts the wash at regular intervals to prevent crystallization (anti-crystallization) on the rollers. At programmable time intervals, anti-oxidation activates a replenishment cycle to prevent oxidation of the chemicals. During this cycle, the film processor accepts the media.

1. Press button **3**.
2. Select:
 - **Options**
 - **Standby**
3. Press button **7**.
4. Press button **8** to scroll through the pages (see below for more details).
5. When the page you want appears:
 - a. Press button **6** to move the cursor to the value you want to set.
 - b. Press button **7** to select and change the value.
 - c. Repeat a and b for each value you want to set.

6. If you want to:

Save and store the values	Cancel the values
Press button 6 to move the cursor to Save , and press button 7 to store the values.	Press button 6 to move the cursor to Cancel , and press button 7 to cancel the values.

7. To return to the work mode, press button 4.

If the display says	Description
SB dryer drop 10	The dryer drop is a value that defines how many degrees C the dryer temperature can go below the programmed value when the film processor is in Standby mode. When the temperature decreases by 10 °C, the heater and fan are activated to warm up the dryer.
SB replenishment 100 ml each 6 h	The film processor will activate a 100 ml replenishment cycle every six hours (anti-oxidation cycle).
SB self-cleaning 20 cm each 10 min	The film processor activates two roller turns (one roller turn = 10 cm) every 10 minutes (anti-crystallization cycle).
Save	Saves and stores the value
Cancel	Cancel the value

Use the Manual Replenishment Cycle

There may be times, such as cleaning, when you need to run the replenishment cycle manually.

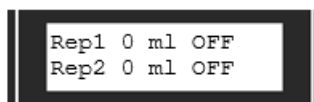

1. Press button **5**, and then select **Rep**.
2. Select **Rep 1** for replenishment tank 1. This adds 100 ml. The **Off** indicator changes to **On**, indicating that the replenishment pump is working.
3. To add more replenishment, press button **7**. Add the replenishment in quantities of 100 ml. You do not need to wait for the replenishment pump to finish.
4. Repeat steps 3 and 4 for **Rep 2**.

NOTE:

A quantity of 2000 ml of manual replenishment or a maximum working time of 25 minutes for the pump is allowed (whichever is greater).

5. To return to the work mode, press button **4**.

Check the Errors

At the start of the workday, the temperature in the tanks is likely to be low. As a result, the *ER* indicator appears without an alarm. If the temperature in the tanks decreases during the workday, the alarm is activated. If an error occurs, P1 or M1 will alternate on the display with *ER*.

1. Press button **2** to stop the alarm and access the **Error** menu.
2. Press button **8** to scroll the page and view additional errors.
3. Resolve the error. See the section: [Error Messages](#).
4. To return to the work mode, press button **4**.

Start and Stop the Film Processor Manually

You can start and stop the film processor manually only when the film processor is not processing the media. When the film processor is processing the media, you cannot move the cursor to select these options.

When you start the motor manually, **M1** (not P1) appears on the main page.

To run the motor manually:

1. Press button **5** to access manual operation.
2. Press button **6** to move the cursor to **Start**, and press button **7** to and select **Start**. This starts the motor. The **Start** option changes to **Stop**.
3. Press button **7** to stop the motor.
4. To return to the work mode, press button **4**.

Turn the Back Light On and Off

In a dark room, it might be necessary to turn off the display's back light to prevent exposure. You may also want to turn the back light off if the film processor is unattended, thereby reducing the likelihood of unauthorized individuals operating the film processor. Press button **1** to toggle the back light on and off. When the back light is off, only button **1** is enabled.

Check the Processing Parameters

When you press the main power switch of the film processor to the on (I) position, the processor checks all processing parameters (especially the temperatures) and starts to heat up. The heat-up time depends on the local ambient temperature. During this time (crossover run and heating up), the film cannot be loaded until the *Ready* message appears.

The message, *Crossover run*, indicates that the processor has automatically started a cleaning cycle for the programmed number of minutes. Do not load the film until the message disappears.

Loading the Film

To prevent the film from overlapping during loading, you must maintain a minimum distance between the films. If you see the message, *Don't feed*, wait until the message disappears. A feed signal indicates that you can load the film.

Using the Monitor Mode

Use the monitor mode to check some of the parameters of the film processor.

1. Press button **5** to access manual operation.
2. Press button **6** to move the cursor to **Monitor**, and press button **7** to and select **Monitor**. The parameters appear.
3. Press button **8** to scroll through the pages.
4. To return to the work mode, press button **4**.

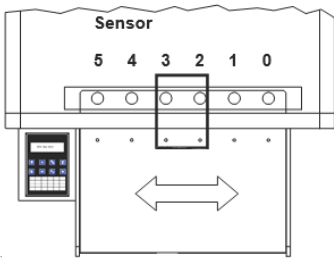
If the display says:	Description
<div style="border: 1px solid black; padding: 5px; width: fit-content;"> DDDDDFFFWWWDDDD --- -- </div>	<p>The first DDDD represents the developer tank, FFFF represents the fixer tank, WWWWW represents the water, and the last DDDD represents the dryer. The dashes indicate the position of the media in the film processor. The wash and crossover water flow only during a process cycle for water saving. Each film is tracked while it is in the film processor. The software can track up to 70 films. Two films running in parallel are tracked as one film. Tracking starts when the film enters the infeed sensor bar.</p>
<div style="border: 1px solid black; padding: 5px; width: fit-content;"> Motor Off / On Speed 19 001 </div>	<p>The motor is on or off. The speed is 19 tach pulses. The number of pulse counts from the tachometer is 001.</p>
<div style="border: 1px solid black; padding: 5px; width: fit-content;"> Normal s-bar Area=0.0000 sqm. </div>	<p>A six-position sensor bar is the norm for the film processor. This includes the loading area. A visual check on the programmed area replenishment cycle occurs every 0.125 sq meter.</p>
<div style="border: 1px solid black; padding: 5px; width: fit-content;"> S-bar: ----- ----- </div>	<p>This feature checks the six integrated sensors. To check the sensors: Place a small piece of film under each sensor, sequentially and one at a time. Do not feed the film into the film processor. When moving the film, check the display:</p> <div style="text-align: center;">  </div>
<div style="border: 1px solid black; padding: 5px; width: fit-content;"> S-bar: ----- -----10 </div>	<p>Sensors 1 and 0 are occupied.</p>
<div style="border: 1px solid black; padding: 5px; width: fit-content;"> S-bar: ----- -----32-- </div>	<p>Sensors 3 and 2 are occupied.</p>
<div style="border: 1px solid black; padding: 5px; width: fit-content;"> H1=0 H2=0 H3=1 Fan=1 Wat=1 Cr=0 </div>	<p>Heater tank 1 is off. Heater tank 2 is off. The heater dryer is on. The dryer fan is on. The wash valve is on. The crossover is on.</p>
<div style="border: 1px solid black; padding: 5px; width: fit-content;"> Refill1 0000 Refill2 0000 </div>	<p>The automatic developer and fixer tank fill when the switches for the in-tank levels are installed.</p>
<div style="border: 1px solid black; padding: 5px; width: fit-content;"> Total area sqm 0000.00 </div>	<p>The total area of the film that was loaded into the processor is displayed.</p>
<div style="border: 1px solid black; padding: 5px; width: fit-content;"> Date: dd.mm.yy Time: hh:mm:ss </div>	<p>The date and time are displayed.</p>

Using the Filter Control

At each replenishment, the total processed area is checked for exceeding the alert value. When the value is exceeded, an error message, *Change filter*, appears.

1. Press button **3** to access the setup mode.
2. Press button **6** to move the cursor to **Options**, and press button **7** to and select **Options**.
3. Press button **6** to move the cursor to **Filters**, and press button **7** to and select **Filters**. The area log appears.
4. Press button **8** to scroll through the pages.
 - The **Area** menu sets the number of square meters before the filter alert. The value is 0000–9999. A value of 0000 turns off the filter alert.
 - The **Log** menu shows the total area processed. This value is stored in the NVRAM. The value is updated each time a replenishment is initiated. It depends on the **Replenish after** variable from the setup. For example, if **Replenish after** = 0.125 sqm, the total processed area is increased by 0.125 sqm at each replenishment.
5. If the message, *Change filter*, appears, it is time to change the filter.



IMPORTANT:

Contact qualified service personnel. Only qualified service personnel may replace the filter.

6. After changing the filter, select **Options>Filter>Log** and clear the processed area to start the counter for the new filter at 0.
7. To return to the work mode, press button **4**.

Additional Features – Auto-fill Water / Auto-fill Chemicals (Dev & Fix)

These functions are optional / only available if your processor is equipped with floating level switches:

- Automatic wash tank fill
- Automatic developer and fixer tank fill

Automatic Wash Tank Fill

This feature ensures that the wash tank will be filled up to the normal water level when the processor is started. This feature is monitored and triggered using an additional level sensor in the wash tank to inform the film processor controller about the level of water in the tank.

If the wash tank does not reach normal level (level switch not activated) within a programmed number of minutes (setup value), the electronics will assume that there is a water supply problem, and an error message displays: *Can't fill water*.

To activate or deactivate this feature:

Press the button **3**, use **6** to move the cursor under **Options**, and press **7**. You will see:

```
Standby Refill
Filter Service
```

Press **6** again to move the cursor under **Refill**, then press **7**. You will see:

```
Wash auto refill
x (1=yes, 0=no)
```

Press **7** to set **1** or **0**. Then press (3x) **8** to leave the menu. You will see:

```
Save Cancel
```

Press **7** to **Save**.

Automatic Developer and Fixer Tank Fill

This feature automatically corrects low-level conditions in the developer and fixer chemical tanks with the use of additional level switch monitoring circuits.

If any tank "low level" sensor is present and activated, a replenishment cycle will inject solution (**XXml**) into the chemical tanks until the correct tank level is reached.

** XXml** this amount is programmable and relates to the size of the film processor.

In the case of a leak in the tank or the associated circulation system and to avoid the replenishment pumps operating continuously and thereby draining and wasting replenishment chemicals, there is a built-in fail safe system that will disable the replenishment pumps if the level in the tank cannot be reached after 2000 ml of replenishment. The pump stops and the message *Tank x Low Level* displays.

To activate or deactivate this feature:

Press the button **3**, use **6** to move the cursor under **Options**, and press **7**. You will see:

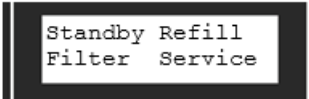

Press **6** again to move the cursor under **Refill**. You will see:

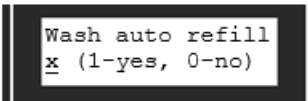

Press **8** (1x). You will see:

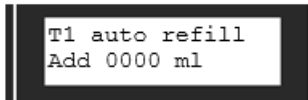

In this case (0000 ml), the automatic chemical tank fill function is deactivated. To activate it, enter a value (in milliliters). To do so, move the cursor under the zeros by pressing **6**. To set a value, use **7**.

Use the same procedure for tank 2 as described for tank 1.

When finished, press **8** (1x) to leave the menu. You will see:

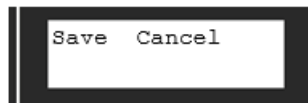

Press **7** to **Save**.

Systems

Tempering

The film processor features an indirect tempering system to maintain the processing solution temperatures accurately and efficiently. This system is integrated with recirculation, offers more efficiency, and saves energy.

The control panel activates the circulation pumps and the tempering unit. The circulation pumps mix the chemicals to ensure even temperatures throughout the tank. The drive motor activates to prevent a build-up of chemicals on the processing racks during periods of low usage. To protect against overheating, the film processor is equipped with a cold water cooling system.

Temperature Sensing

The temperature probes in the tanks sense the change in temperature and activate the correct heater control circuits (using the main processor control system), which maintains accurate solution temperatures. Also, a temperature sensor for the incoming cooling water is present. When the temperature is outside of a programmed range, a beeper alerts the operator, but does not affect the operation of the processor.



IMPORTANT:

The temperature probe for the dryer must be removed whenever the dryer rack is removed and re-installed when the dryer rack is re-installed.

Temperature Probes

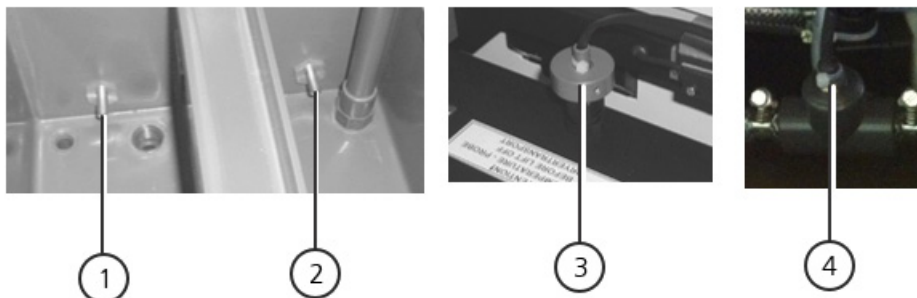

Number	Tank	Color of the Probe
1	Developer	Yellow
2	Fixer	Blue
3	Dryer	Red
4	Cooling water in	Yellow-yellow

I2C Bus

The temperature probes, positioned below the solution levels, monitor the temperatures in the solution tanks and continuously provide the solution temperatures to the microprocessor. The microprocessor compares the actual temperatures to the required (set) temperatures and controls the heating and cooling systems as needed. The I2C bus system transfers the information.

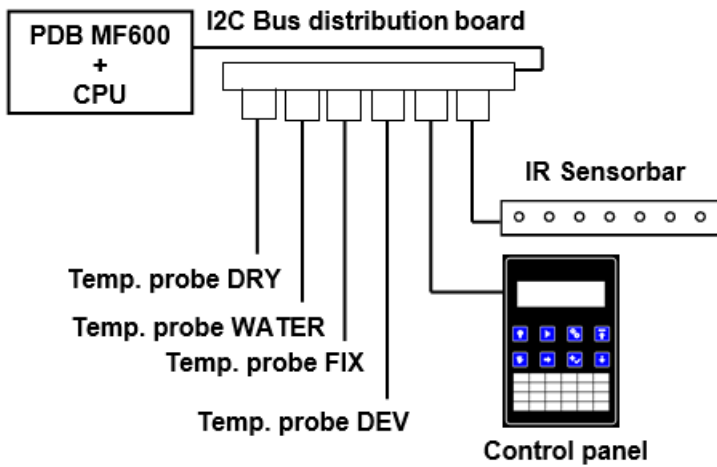

Bus System	Measures the temperature in	Actions
Temperature probe	Developer and fixer	Heating and cooling
	Dryer	Heating
	Cooling water in	Monitoring
Sensor bar	Incoming film area	Replenishment

Ventilation

A ventilation device prevents crystallization and humidity inside the housing of the film processor. It is required to connect the exhaust port to an external exhaust device to prevent any possible film deposits or corrosion inside the film processor and improves the drying efficiency.



IMPORTANT!

Only qualified service personnel can install an external exhaust device.

It is important to connect the film processor's exhaust port to an external exhaust device, provided at the installation site, to have the correct airflow through the film processor. This, in turn, maximizes the dryer efficiency and prevents condensation and potential corrosion problems.



Exhaust port

Chemical Replenishment

When photographic material is processed, the chemical components of the processing solutions release by-products in the processing solutions. Replenisher solutions are formulated to restore the chemical to its original activity and to dilute the products to an acceptable level. It is, therefore, necessary to add the correct amount of replenisher for material that has been processed. This occurs automatically by using infrared sensors that are installed across the width of the film feeder.

These sensors emit pulses of infrared light that have no effect on photographic emulsions. When media is under the sensor bar, the sensor reflects and detects the pulses. The pulses are transmitted to the control panel and are counted by the microprocessor. When the number of pulses reaches the number that has been programmed on the microprocessor, the replenishment timer starts.

The replenishment timer runs the replenishment pumps for the time that the microprocessor has calculated. When the replenishment pumps are activated, the replenisher solutions are pumped through the filters, located at the bottom of the external replenishment tanks, and to the chemical tanks. The replenishment tanks are outside the film processor. The filters should be checked monthly and cleaned or replaced if necessary. See [Using the Filter Control](#).

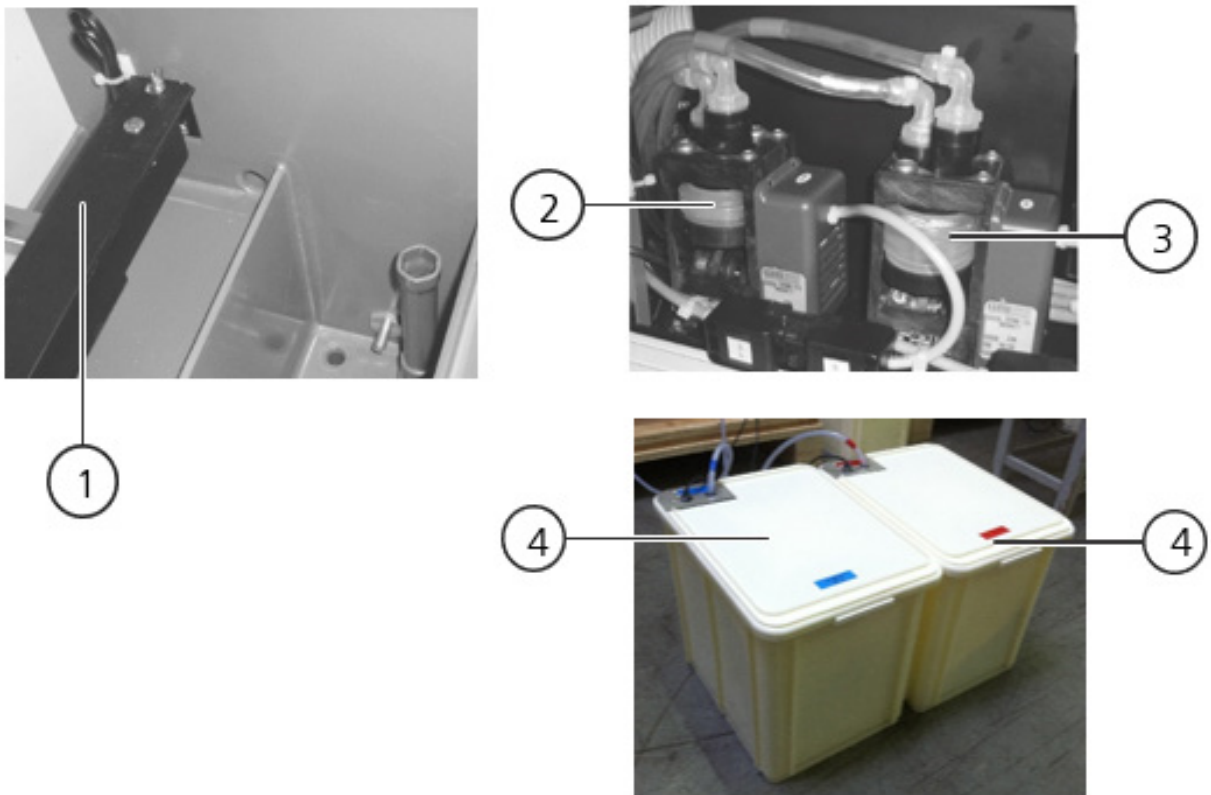

1	Sensor bar
2	Replenishment pump for the developer
3	Replenishment pump for the fixer
4	External replenishment tanks

Infrared Sensor Bar

The automatic replenishment system uses an infrared sensor bar to detect the incoming film area. With that information, the CPU for the film processor calculates the replenishment rate. It is important to keep the entrance rollers clean and dry and to avoid chemical or water spills on the feed tray, feed rollers, and sensor bar. Spills must be cleaned immediately. See [Daily Maintenance](#).

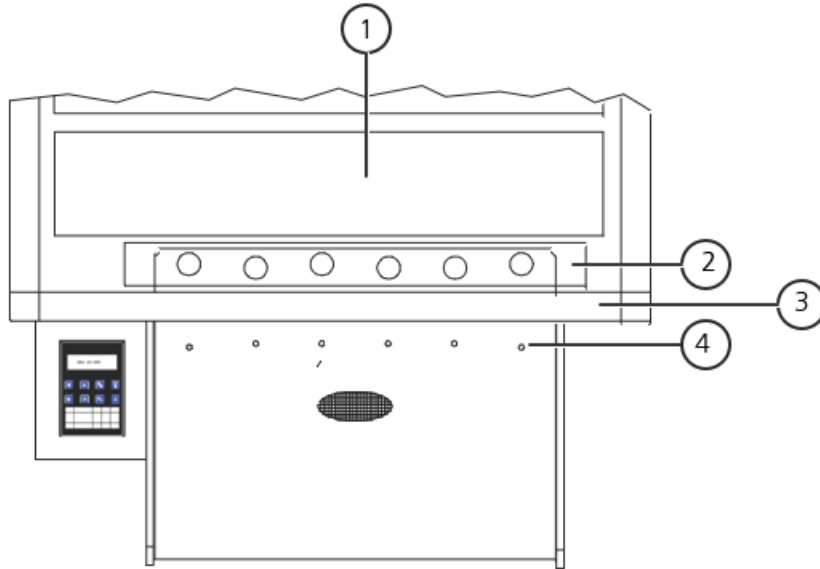

1	Developer rack
2	Sensor bar with six infrared sensors
3	Main frame of the film processor
4	Input guide with holes

The holes in the film input guide indicate the position of the sensors.

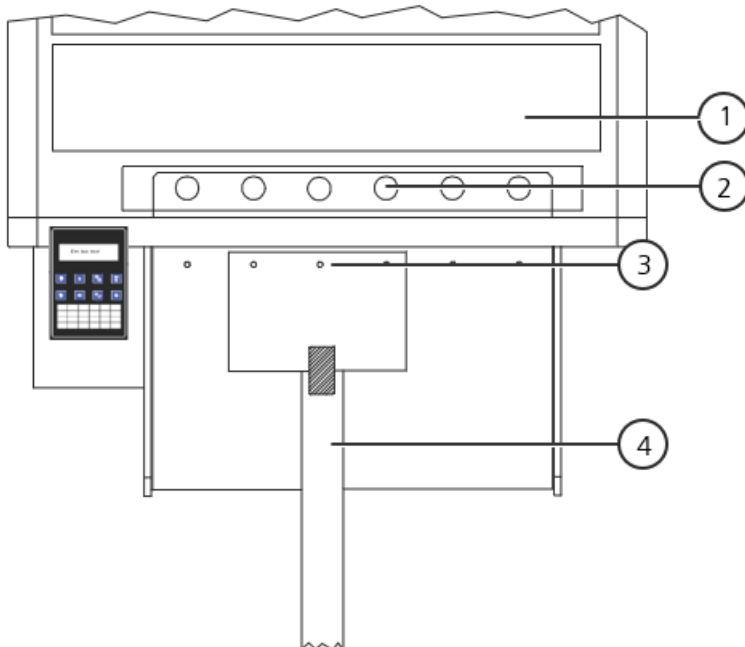

When processing roll films:

- Use a leader and feed table loading guide.
- Check that a minimum of one sensor detects the film.

Maintenance, Troubleshooting, and Error Messages

Daily Maintenance



CAUTION:

- Wear safety goggles, gloves, and protective clothing.
- Always observe the safety warnings.



ESD:

Isolate the film processor from the mains power by switching the main power switch of the film processor to the off (0) position.



1	Main power switch
2	Service cover

1. Check the levels of the external replenishment tanks. If necessary, mix a fresh solution.
2. Clean the feed tray.
3. Before starting production, feed some cleaning films to remove any residue.



IMPORTANT:

Be careful to always keep the infeed rollers dry.

4. Use a spray bottle with warm water to remove deposits from the drive gears.



Weekly Maintenance



CAUTION:

- Wear safety goggles, gloves, and protective clothing.
- Always observe the safety warnings.



ESD:

Isolate the film processor from the mains power by switching the main power switch of the film processor to the off (0) position.



1	Main power switch
2	Service cover

1. Use a wet cloth to wipe the enclosures, panels, and other external surfaces of the film processor. Remove any chemical or dirt deposits.
2. Check and clean the wash tank and intermediate water rinse drains. If algae are present, use a reputable algae control system to remove.
3. Check the drain pipes and overflow tubes. Remove any deposits to prevent a blockage of the drain.

Drain Pipes and Overflow Tubes

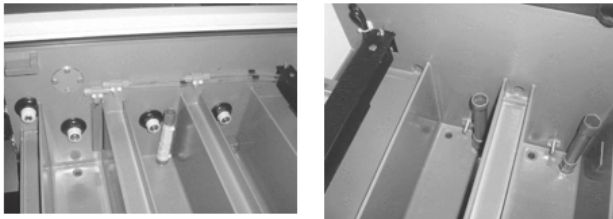

Three-to-Six Months Maintenance



CAUTION:

- Wear safety goggles, gloves, and protective clothing.
- Always observe the safety warnings.



ESD:

Isolate the film processor from the mains power by switching the main power switch of the film processor to the off (0) position.



1	Main power switch
2	Service cover

Good processing quality and the reliable operation of a film processor is dependent on regular and careful cleaning. Every 3-6 months, the chemicals in the tanks should be drained. A chemical cleaning of the processing

tanks and wash tank is recommended. Always follow safety warnings as described in this manual when cleaning the film processor.

1. Switch the main power switch of the film processor to the off (O) position.
2. Remove the top cover of the film processor.
3. Drain the individual tanks by opening the drain taps at the front of the film processor.
4. Remove the rack assemblies for the water, developer, and fixer, and set to the side.
5. Close the taps and fill all tanks with water or a suitable cleaning solution up to the red mark inside the tanks.

 **NOTE:**

If you are using a cleaning solution, follow the manufacturer's instructions.

6. Place the racks back into the tanks and close the top cover.
7. Switch the main power switch of the film processor to the on (I) position and start some replenishment cycles. This cleans the hoses with water.
8. With the racks in the tanks, start the transport cycle. Allow the film processor to run for 10 to 15 minutes.
9. Switch the main power switch of the film processor to the off (O) position and drain the tanks again.
10. After cleaning the tanks, fill the developer and wash tanks with fresh water two times. Use a neutralizer that is recommended by the manufacturer.
11. Allow the film processor to run again for approximately 10 minutes.
12. Check the external hose connectors outside of the film processor and the fittings for leakage.
13. Drain all the tanks.
14. Remove the water, developer, and fixer racks, and check for:
 - Worn gears
 - Damaged or worn bearings
 - Loose screws
 - Scratched or bent film guides
 - Flat rubber springs in the underturn at the bottom of the developer and fixer racks
15. Have qualified service personnel do any necessary repairs.
16. Check the inside of the tank for contamination and foreign substances.
17. Clean the rollers thoroughly.
18. Close the drain taps of all three tanks.
19. Fill the fixer tank to the required level using fresh chemicals.
20. Fill the developer tank to the required level using fresh chemicals.
21. Install the racks carefully.
 - Check that the correct sequence of the racks is followed. See [Installing the Transport Racks](#).
 - Check that the gears are in the correct position.
 - Secure the racks. See [Installing the Transport Racks](#).
22. Insert the correct suction pipe to the correct external replenisher tank.
23. Install the top cover.
24. Switch the power switch of the film processor to the on (I) position.
25. Process the test films.

Troubleshooting

Item	Problem	Cause	Solution
1	Tank 1 is too cold. The developer temperature is more than 1 °C below the programmed value.	The developer bath temperature is too low.	Check the heat-up time. Check the developer temperature for 1 °C increase of temperature every 2-3 minutes.
		There is a heater problem.	Check in the monitor mode H1. Check LD3 on the main board. Check the fuse F3.
		There is no circulation in the bath.	Check the circulation pump. Check LD7 on the main board. Check the fuse F7.
2	Tank 1 is too warm. The developer temperature is more than 1 °C above the programmed value.	The water tap is closed, and no cold water is entering the film processor.	Open the water tap.
		The cooling valve doesn't work.	Check if LD9 on the main board is on and check the fuse F9. If OK, replace the cooling valve.
3	Tank 2 is too cold. The fixer temperature is more than 1 °C below the programmed value	See point 1.	See point 1. Check the fuse F4 and LD4 (output fixer heating). Check the fuse F7 and LD7 (output circulation).
4	Tank 2 too warm. The fixer temperature is more than 1 °C above the programmed value.	See point 2.	See point 2. Check the fuse F9 and LD9 (output cooling).
5	The dryer is too warm. The dryer temperature is more than 5 °C above the programmed value.	The set temperature is too low (lower than room temperature).	Change the set temperature.
		The main board is defective.	Change the main board.
		The solid state relay is defective.	Change the solid state relay.
6	The motor overloaded. The drive motor did not reach its set speed.	The main drive assembly is blocked.	Check that the main drive is running easily.
		The main drive chain has too much tension.	Check the chain.
		There is a film jam in the racks.	Check the racks.
7	An emergency stop has occurred.	The cover of the machine is not closed correctly.	Check the machine cover.
		The cover switch is damaged.	Check the function of the cover switch.
		An emergency stop is active.	Check whether the e-stop is depressed.

Item	Problem	Cause	Solution
		The safety relay is defective.	Check that the relay is functioning.
8	The main drive and the dryer run continuously.	The main drive was started in manual mode.	Check in the manual program if STOP is shown; stop the transport with the button.  IMPORTANT! If an automatic cycle is also started by the sensor bar, this cycle ends first.
		There is material always under the sensor bar. The material is not transported/pulled into the processor.	Check the input rubber roller. Check whether a film is on the film table under the sensor bar.
		The sensors at the sensor bar are wet or dirty.	Clean the sensors.
		The main board is defective.	Change the main board.
9	The material is wet when exiting the film processor.	The dryer temperature is too low.	Increase the dryer temperature (max. 60 °C).
		The transport speed is too high.	Lower the transport speed.
		The developer or the fixer is incorrect or unusable.	Increase the replenishment rate or change the chemicals.
		The dryer blows cold air only.	The fuse F1 of the dryer heater, the solid state relay, or the dryer heating elements are defective. The thermo switch for the heating element is open.
10	Temperature problems occur. The temperature is shown incorrectly.	The temperature probes must be positioned according to their codes.	The temperature probes are color coded. <ul style="list-style-type: none"> • Developer: yellow • Fixer: blue • Dryer: red
11	There is no fresh water.	The water tap is closed.	Open the water tap.
		The water valve is blocked or faulty.	Clean the small filter in the valve or replace it.
		The main board is defective.	Check the fuse F8 and LD8. Call for service.
12	The circulation pump does not work.	The pump wheel is blocked by dirt.	Clean the pump wheel and ensure easy running.
		There is no electrical power.	Check the fuse F7 and LD7. Call for service.
13	The level of the water tank is too high. The water tank	The water drain or overflow is blocked.	Clean the water tank, the overflow, and the water drain.
		The waste water drain is installed incorrectly.	Modify the water drain installation.

Item	Problem	Cause	Solution
	overflows.		
14	The level of the developer tank is too low. The level of the fixer tank is too low.	The tank leaks.	Seal the tank leak. Call for service.
		The replenishment rate is too low.	Increase the replenishment rate.
		The anti-oxidation cycle is too long.	Decrease the time of the anti-oxidation cycle.
		The replenishment container is empty.	Fill the replenishment container.
		The replenishment pumps have no electrical power.	Check the fuses F5 and F6. Check the LEDs LD5 and LD6. Clean the replenishment pump or replace it.
15	The chemical does not reach its temperature.	The temperature is incorrect.	Program the temperature correctly.
		The temperature sensor is faulty.	Replace the temperature sensor.
		The processor was started with no liquid in the tanks. The safety fuses at the heating element interrupted the current supply.	Reset the safety fuse.
		The Power Distribution Board (PDB) is faulty.	Replace the PDB.
16	The materials show scratches or pressure marks.	The processing materials were handled improperly.	Handle the materials carefully.
		The crossover rollers are dirty.	Clean all rollers above the fluid level.
		The guide bars are bent.	Clean and check the guide bars. If necessary, replace them.
17	The material remains in the processor.	The material was fed incorrectly.	The material must be fed in straight.
		The material has excessive curl.	Fold the leading edges and feed into the processor.
		The material is too thin.	Use a leader to process.
		The rollers are not rotating.	Check the gears and the position of the loose rollers.
18	The film processor could not be switched on.	The main cable is not plugged in.	Plug in the main cable correctly.
		The main fuse is faulty.	Check the main fuse F1.
19	The paper or the film is too dark.	The temperature of the developer is too high.	Decrease the developer temperature.
		The processing time is too slow.	Increase the processing time.
		The exposure time is too long.	Reduce the exposure time.
		After adding new	Add the starter according to the

Item	Problem	Cause	Solution
		chemicals, the starter is missing.	instructions.
20	The paper or the film is too light.	The temperature of the bath is too low.	Change the bath temperature to the recommended value or change the chemicals.
		The transport speed is too high.	Decrease the transport speed.
		The exposure time is too short.	Increase the exposure time.
		The bath level is too deep (there is no heating and circulation).	Fill the bath to the correct level and check the replenishment tanks.
		The developer is exhausted.	Replenish or change the chemicals.
		The fixer is mixing with the developer (the developer becomes cloudy).	Carefully clean the tank and replace the chemicals.
		The exposure settings are incorrect, or the machine is faulty.	Adjust the settings or repair the faults.
21	The paper or the film is foggy.	There is a light leak in the darkroom or in the cassette.	Seal the light leak.
		The darkroom light is incorrect.	Check the filter, the wattage, and the distance between the darkroom lamp and the film processor.
		The material is out of date.	Check the expiration date of the material.
22	The surface of the paper or the surface of the film is yellow-green.	The material is not suitable for the film processor.	Use only material suitable for roller processing.
		The fixer is exhausted.	Replenish or change the chemicals.
		The level in the fixer bath dropped. (The temperature safety fuse was activated.)	Check the levels of the replenishment containers and fill the bath to the required level.
		The circulation pumps failed.	Check the pump motor and replace it, if necessary.

Error Messages

The film processor is designed to produce a consistent, high quality with a minimum of maintenance. Regular maintenance minimizes the chances of equipment failure and loss of processing quality.

A well-trained person who is familiar with the operation and function of the film processor must be responsible for maintenance.

Display	Reason
Tank1 too cold	This is normal during the heat-up period. The developer is heated until the set temperature is reached.

	If an error message is displayed, call qualified service personnel.
Tank1 too warm	The developer temperature is more than 1 °C above the set temperature. Call qualified service personnel.
Tank2 too cold	This is normal during the heat-up period. The fixer is heated until the set temperature is reached. If an error message is displayed, call qualified service personnel.
Tank2 too warm	The fixer temperature is more than 5 °C above the set temperature. Call qualified service personnel.
Dryer too warm	The actual temperature in the dryer is more than 5 °C above the set temperature. Call qualified service personnel.
Motor overload	The drive/transport system is not running when activated. The drive motor does not reach its set speed. Call qualified service personnel.
Emergency stop	The top cover of the film processor is open. Close the cover. The emergency stop is active. Deactivate.
T1: no probe	The temperature probe in tank 1 is defective or missing. Call qualified service personnel.
T2: no probe	The temperature probe in tank 2 is defective or missing. Call qualified service personnel.
T3: no probe	The temperature probe in the dryer is defective or missing. Call qualified service personnel.
Change filter	The filter medium must be replaced. Call qualified service personnel.
If the film processor is equipped with optional level sensors, the following messages may display.	
Tank1 low level	The chemical level in tank 1 is too low.
Tank2 low level	The chemical level in tank 2 is too low.
Water low level	The level of the water tank is too low.
Water overflow	The drain of the water tank is blocked. Call qualified service personnel.
Rep. T1 low level	The replenishment tank for tank 1 is empty. Refill the tank.
Rep. T2 low level	The replenishment tank for tank 2 is empty. Refill the tank.

Publication History

Date	Changes
27MAR15	New Publication
23MAR18	Changed RDM No.
20MAR19	Chapter 2.2, corrected descriptions
2021-09-10	Rebranded for Carestream. Minor updates for consistency with the M43ic manual. Added information from service bulletins Oct 2017 and Aug 2018: Adjusting water flow rate and filter in "down" position. Previous part number (COLENTA): RDM 10-1/43/2311/S0/C



Colenta Labortechnik GmbH & Co KG
Neunkirchner Str. 117
A-2700 Wiener Neustadt
Austria

© Colenta Labortechnik GmbH & Co KG 2019

Carestream is a distributor of the INDUSTREX M37 Plus Processor.

Carestream Health, Inc.
150 Verona Street
Rochester, NY USA 14608

CARESTREAM and INDUSTREX are trademarks of Carestream Health.

Pub. No. CHSP-9040
Rev. A

