

Site Specifications  
INDUSTREX M43ic  
Film Processor

Non-Destructive Testing (NDT) Applications



## Getting Started

The processor is designed in such a way that only a cold water supply, drain, and power connection are necessary. The plumbing is carried out according to DIN 1986/1988 and must comply with local plumbing codes. The cold water supply must have a shut-off valve / tap system connected with a ¾ in. outlet (washing machine connection) to the processor.

Make sure that the water supply tap is always accessible, as it must be opened before work and closed after work. Using the pressure/flow regulator, which is integrated into the water solenoid valve of the processor, the flow rate is limited to maximum 2.5 L/min at a water supply pressure of 2–6 bar. See the section on *Plumbing Requirements* for more information.

For cleaning the racks and the film processor tanks, as well as mixing the chemicals, it is recommended to install a second water supply outlet (with shut-off tap) and with approximately 2.5 m (8.0 ft) of hose.

The fixer can be collected separately in a plastic container (storage tank) or directly connected to a silver recovery unit. The developer overflow can be collected in a plastic container.

To avoid a backwash of the drained, used chemicals, the drain hoses should be free of bends and with a constant fall. The drain tubes of the processor can be drained separately or together, according to local regulations and health/safety requirements. The hose connections from the processor to the outlet (drain) are enclosed. A floor or wall drain may be used, which should include an anti-syphon system. **The drain must be correctly ventilated! Do not use brass or copper in the drain lines.** The minimum diameter of the drain lines should be 40 mm.

## Electrical

The processor is rated **16 A**. Use a separate fused socket with earth leakage protection that meets the processor requirements and local regulations. The processor may require its own circuit. For more information, see the Technical Data / Reference doc (CHSP-9013).



### Important!

In countries where the electrical supply is 60 Hz, the replenishment pumps must be adjusted to ensure that they deliver the recommended replenisher amount. Contact a qualified service provider to check and make adjustments if needed.

## Replenishment

The replenisher storage tanks should be located on ground level with easy access. Note the required minimum wall clearance for servicing and cleaning.

## Automatic Cooling

The processor electronics automatically detect over-temperature developer conditions and then activate the Chiller. Where a Chiller is not used (older models may not have a built-in Chiller), the temperature of the incoming “mains” cold water supply should be in the range of 10 to 35 °C (50 to 95 °F) for the cooling system to operate efficiently.

## Processor Ventilation

The processor is supplied with an exhaust port, located at the feed end of the processor. During installation, the safety cover of the port should be removed by a qualified service provider, and the open port must then be connected to the main exhaust facility at the installation site (with sufficient power to ventilate the warm exhaust air away).

Where the processor is installed in a “through wall” location, where an auto feeder or feed table is positioned in a darkroom and the main body of the processor is in daylight, it is important that the darkroom is pressurized to ensure a positive airflow from feed to dryer, to avoid condensation related problems. See more details in the following sections.

NOTE: Failure to correctly ventilate the film processor and dryer exhaust may cause corrosion inside the film processor, increasing the likelihood of processor-related film artifacts.

## Environmental Requirements

<b>Room Temperature:</b>	15 to 30 °C (59 to 86 °F)
<b>Relative Humidity:</b>	40 to 76 % (non-condensing over operating temperature range)
<b>Altitude:</b>	Maximum altitude 2,424 m (8,000 ft) above sea level
<b>Ambient Light:</b>	Room lighting should not exceed 450 lux (150 ft-candles) at the processor. The room must be capable of going completely dark when loading film into the processor.
<b>Heat Output:</b>	2,200 Btu/hour
<b>Ventilation:</b>	<ul style="list-style-type: none"><li>• Volume: 10 room air exchanges per hour with good airflow through the whole room</li><li>• 66 °C (150 °F) is typically the maximum dryer temperature set point</li><li>• Exhaust duct from the building with an adjustable air gap of 0.76 to 2.54 mm (0.03 to 0.10 in.)</li><li>• 10.2 cm (4.0 in.) duct</li><li>• If venting is not managed as specified above, fumes will corrode the equipment. <b>Do not install the processor or accessories if the venting is not correct.</b></li><li>• If the processor is installed with an auto-feeder or feed table located in the darkroom and the processor is installed in a daylight location, the darkroom must have adequate pressure to ensure a positive airflow from the feed to the dryer. This should prevent condensation problems.</li><li>• The airflow is correct when the fumes are flowing out the processor through the exhaust hose.</li><li>• If the ventilation is to be connected to the processor, measure the negative static pressure in the exhaust duct. See page 7.</li></ul>

**IMPORTANT:**  
**Check local codes for venting requirements.**

## Plumbing Requirements

<b>IMPORTANT:</b> <b>All plumbing requirements must comply with local and national codes.</b>	<ul style="list-style-type: none"><li>• All drain material must be made of chemically resistant, non-corrosive material.</li><li>• <b>Use PVC or equivalent.</b></li><li>• <b>Do not use iron pipes.</b></li><li>• <b>Do not use brass or copper drainage pipes.</b></li></ul>
<b>Water Supply – Temperature:</b>	<ul style="list-style-type: none"><li>• 10 to 35 °C (50 to 95 °F)</li><li>• If the temperature of the water supply is higher than 35 °C (95 °F), install a water chiller.</li><li>• A tempered water supply is recommended for cleaning the processor and for mixing chemicals manually.</li></ul>
<b>Water Filter:</b>	5 to 10 micron in the input water line; 5 micron filter is optimal
<b>Flow Volume:</b>	2.5 L / min
<b>Pressure:</b>	2–6 bar
<b>Location:</b>	Accessible to both the processor and the replenishment tanks
<b>Hoses:</b>	2-way magnetic valve with 3/4" hose connection using a DVGW (German Technical and Scientific Association for Gas and Water) system device or pipe device
<b>Drain – Size:</b>	<ul style="list-style-type: none"><li>• 32.0 mm (5.4 in.) hose connection</li><li>• Minimum diameter: 7.6 cm (3.0 in.) with no obstructions</li><li>• Distance from processor: 1.5 m (60.0 in.)</li><li>• Height from floor: Top of the drain or drain containers must be lower than the bottom of the processor</li><li>• Capacity: 1 L/min (1/4 gal/min) during normal operation</li></ul>
<b>Drain – Capacity:</b>	<ul style="list-style-type: none"><li>• 1 L/min (1/4 gal/min) during normal operation</li><li>• 2.85 L/min (3/4 gal/min) for draining all three solutions together</li><li>• 0.95 L/min (1/4 gal/min) if each solution is drained separately</li></ul>

## Water Supply, Drain Connection, and Replenishment



### NOTES:

- See more about the exhaust port on page 7.
- Two 50-liter replenishment tanks for the developer and the fixer are supplied with the film processor:



## INDUSTREX Water Control Panel

The Water Control Panel (CAT No. 5504949) is an accessory, designed for CARESTREAM NDT processors, that provides the service connections necessary for adding water monitoring and filtration capability to your processors for cleaner water and higher image quality. Poor water quality can lead to inferior image results, wasted consumables, and maintenance issues. Reliable and clean water is vital in all the processing stages: developer, fixer, and wash. The Water Control Panel ensures that the best possible water conditions are set for flow, pressure, temperature, and filtration for the highest level of image quality.

- Features:**
- Flow Meter: A stable water flow rate ensures that film is washed efficiently for optimum processing quality. Incoming water can be set to the required flow rate specified for the model of processor.
  - Filter Element: 254 mm (10 in.) filter element (5 microns is recommended). Pressure gauge for monitoring water pressure is included.
  - Water Filtration: 254 mm (10 in.) filter housing for use with 5–10 micron filter elements – for small particle capture.
  - Thermometer: Incoming water temperature should be between 7–15 °C for the processor cooling system to operate efficiently in the absence of a chiller.
  - Two Exits: One exit after filtration for cleaning and mixing chemicals / one exit to the processor (includes the water flow meter).
  - Additional “Y” Connector: For adding Auto Mixer capability. NOTE: Installation by a certified plumber is recommended.

### Features

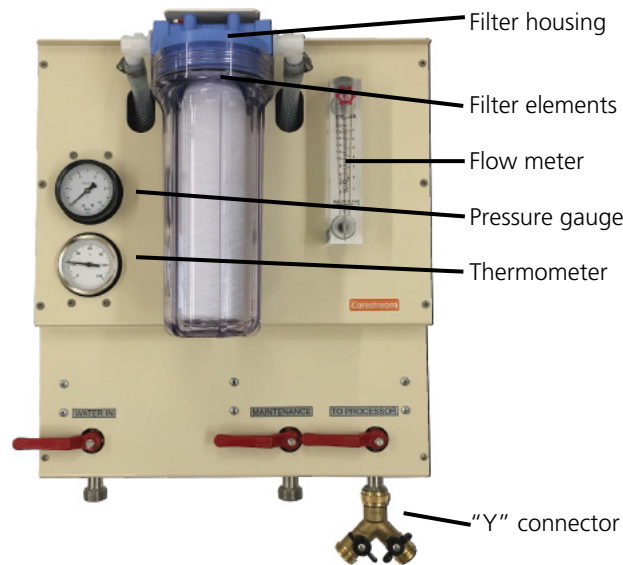

### Dimensions

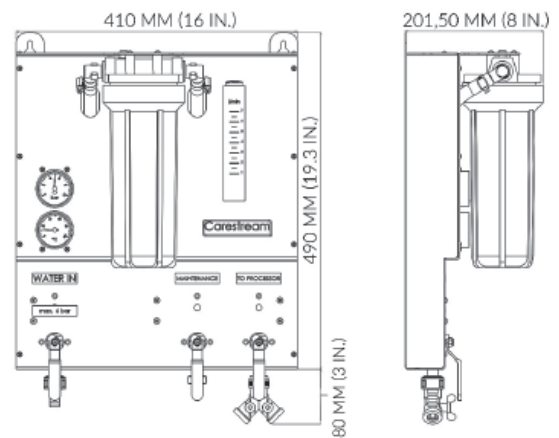

NOTE: Maximum water pressure: 6 bar

# Water Supply Kit Assembly

Order No. 90 60 008

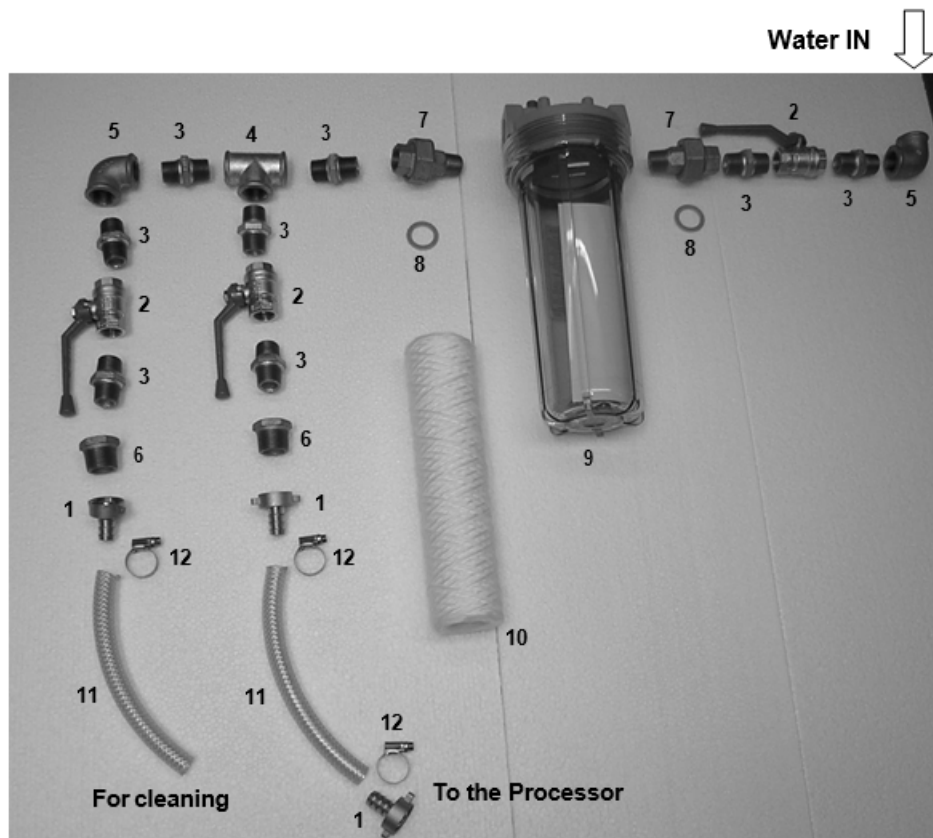

Item	Part No.	Beschreibung	Description	Quantity
1	90 45 000	Schlauchholländer 3/4"	Hose connector - 3/4 in.	3
2	90 45 001	Kugelhahn 3/4"	In-Line tap	3
3	90 45 002	Doppelnippel 3/4"	3/4 in. straight fitting	8
4	90 45 003	T-Stück 3/4"	T-Fitting 3/4 in.	1
5	90 45 004	Bogen 3/4" - 90 °	3/4 in. elbow – 90 °	2
6	90 45 005	Reduzierung	Male/Female fitting	2
7	90 45 007	Holländer	Filter inlet/outlet fitting	2
8	90 45 009	Dichtung	Flat washer	2
9	90 45 027	Filtergehäuse	Filter housing	1
10	90 45 035	Filterpatrone	Filter cartridge	1
11	90 70 420	Schlauch 1/2"	Hose 1/2 in.	4 meters
12	90 81 826	Schlauchklemme	Hose clamp	3

## External Exhaust System

To protect the processor as well as any equipment that may be directly interfaced with the processor, the processor must be connected to an external exhaust system. (Failure to correctly ventilate the processor and dryer exhaust will result in corrosion within the processor and interfaced equipment—in addition, the probability of processor-related film artifacts is increased.) The exhaust system provided at the installation site should comply as follows:

- The disposal of the effluent air must comply with all local environmental safety codes and regulations.
- The following calculation should be used to determine the efficiency of the system provided and that the correct amount of end to be connected to the processor. To prevent the Venturi effect at the duct opening, all measurements should be made at a point 30 cm from the open end of the duct to be attached to the processor.

**Negative Static Pressure – Water Head**  
**At 100 mm tube size: min 0.76 mm – maximum 1.02 mm**

- Measurements can be made typically using a Dwyer Air Meter (see the image below). If such a device is not available, contact your local representative for further information.
- If solid metal or rigid plastic ducting is attached to the processor in a manner that would prevent easy removal, a small hole may be created at a point approximately 30 cm from the processor ventilation port. The “L” shaped metal tube provided with the Dwyer Air Meter can then be inserted through the opening. When measuring negative air, the tube tip opening should be pointed in the direction of airflow away from the processor. The processor must be de-energized when making air measurements. The air meter should be held in the vertical position to assure the greatest accuracy. The meter tubing must not be kinked.

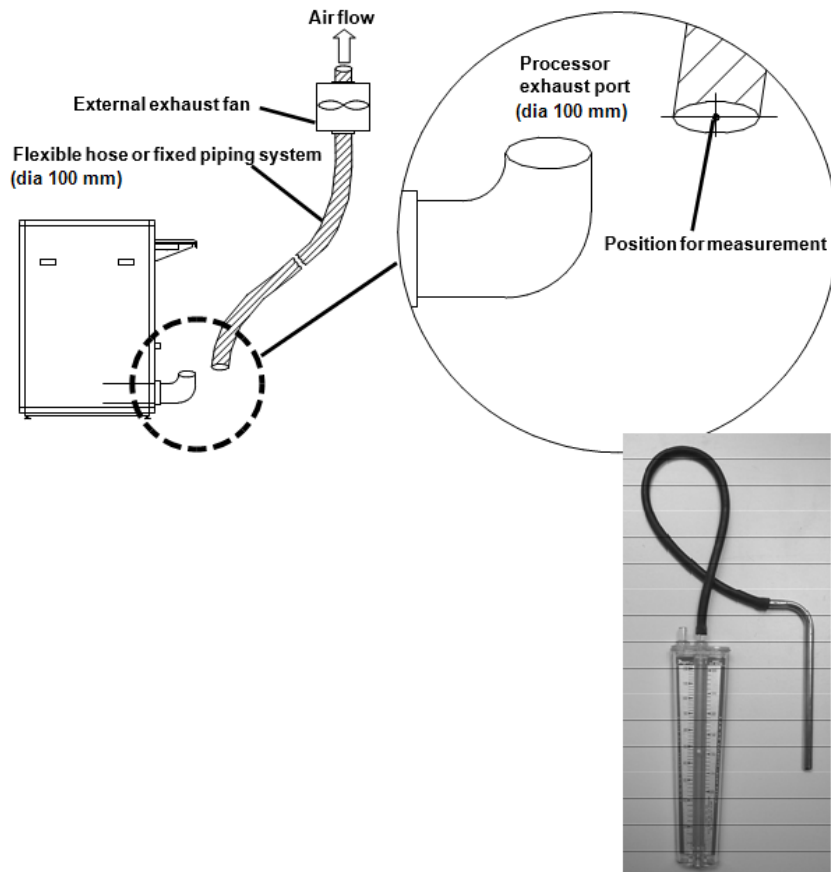

**NOTE: If the ventilation tubing is connected to house-internal exhaust system, an air-gap of 5 cm (2 in.) must be provided accordingly.**

It is most important that negative airflow in the processor exhaust duct remains constant when the processor is in the run, standby, and shut-down modes.

When processors are installed in darkroom wall openings, it is most important that darkroom air pressure exceeds the air pressure of the area surrounding the darkroom. This is intended to prevent air cascading through the processor into the darkroom area. Proper balancing of dark/lighted room air in addition to correct dryer venting will not only maximize containment of chemical fumes and vapors within the processor and its dryer exhausting system, but the incidence of film artifacts occurring in the out-of-solution transport roller sections will be greatly reduced. To prevent positive airflow from flowing back into the processor from the building exhaust, there should be an air gap that does not exceed 5.08 cm (2.00 in.) between the processor exhaust hose and the building exhaust.

This will benefit the site in two ways:

- The gap can be adjusted to provide correct negative flow in cases where building exhaust exceeds requirements.
- Prevents positive flow returning to the processor.



# Recommended Installations

## 1: Free-standing Processor

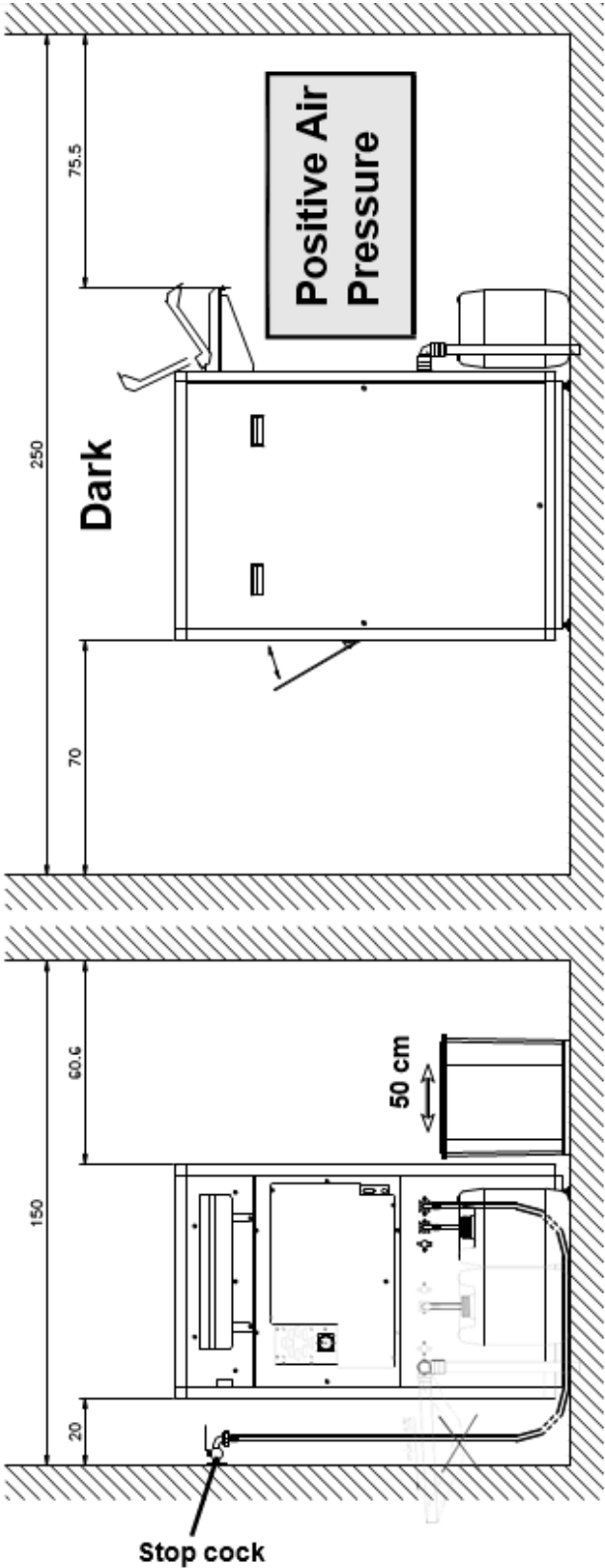

## 2: Processor Darkroom: Exit to Light

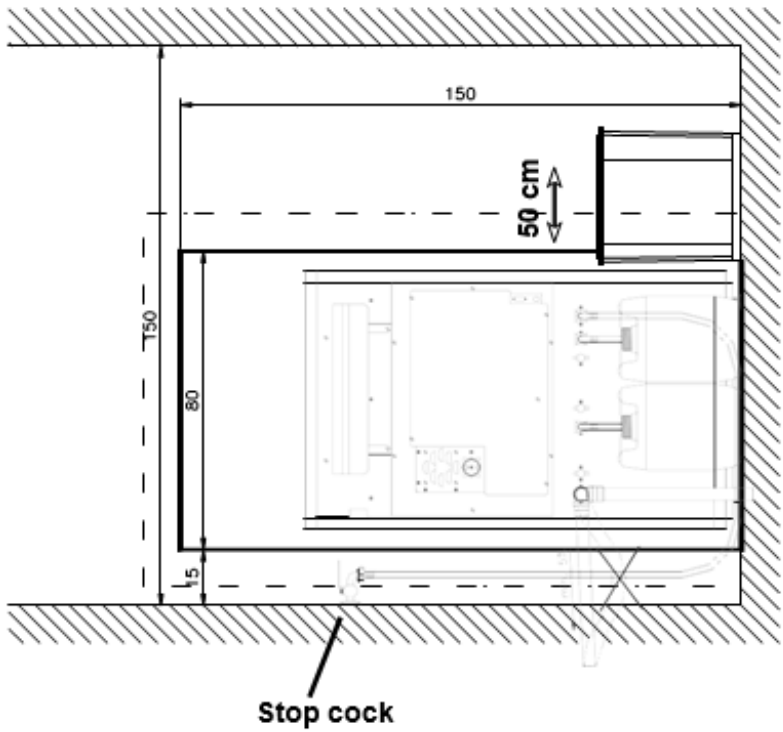
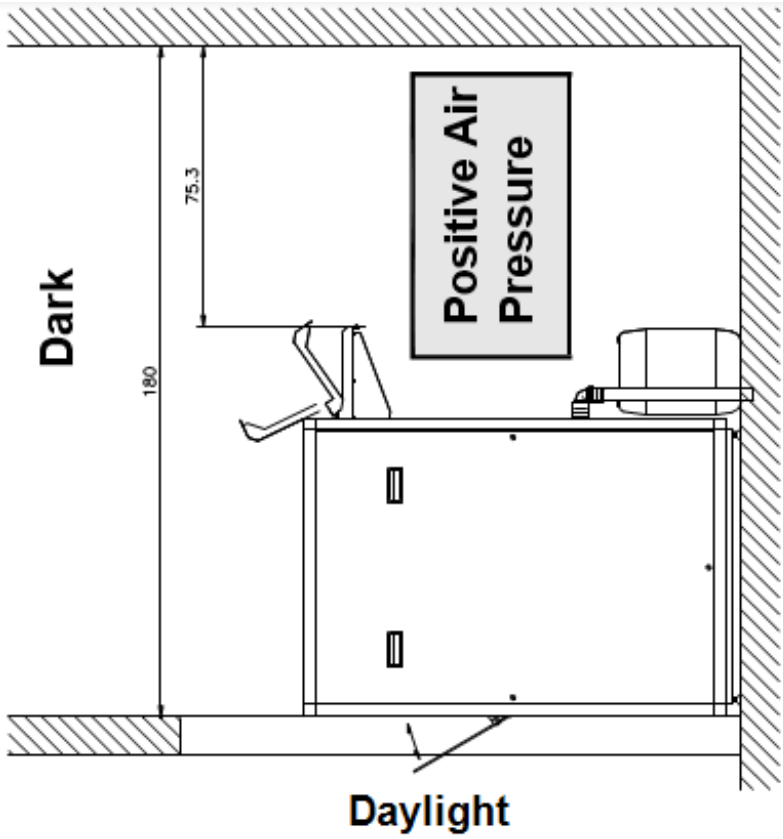

### 3: In-feed in Darkroom / Processor in Daylight

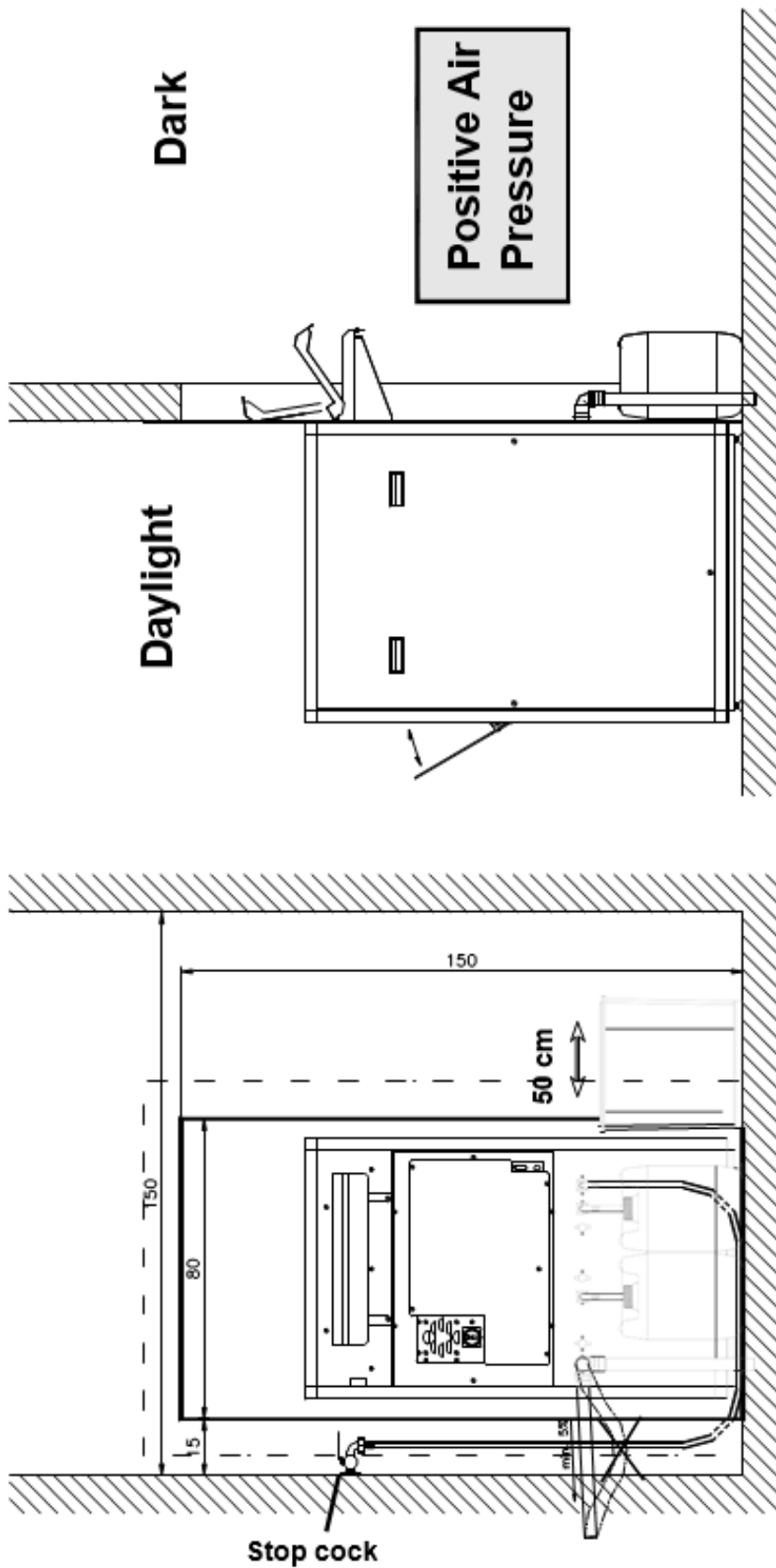



Colenta Labortechnik GmbH & Co KG  
Neunkirchner Str. 117  
A-2700 Wiener Neustadt  
Austria

Carestream is a distributor of the INDUSTREX M43ic Film Processor.  
Carestream Health, Inc.  
150 Verona Street  
Rochester, NY USA 14608

CARESTREAM and INDUSTREX are trademarks of Carestream Health.

Pub. No. CHSP-9022  
Rev. C



Publication History:

2013: Colenta version: X1-25\_4.pdf

2021-05-05, Rev A: Carestream branding was applied. Added information about the Water Control Panel.

2021-08-06, Rev B: Updated the water pressure to 2–6 bar. Added note about countries with 60 Hz electrical supply.  
Updated graphic that shows the 50 L replenishment tanks.

2021-09-10, Rev C: Added note to contact service provider to help with 60 Hz sites' replenishment pumps if needed.